

February 2025

DNWP line card

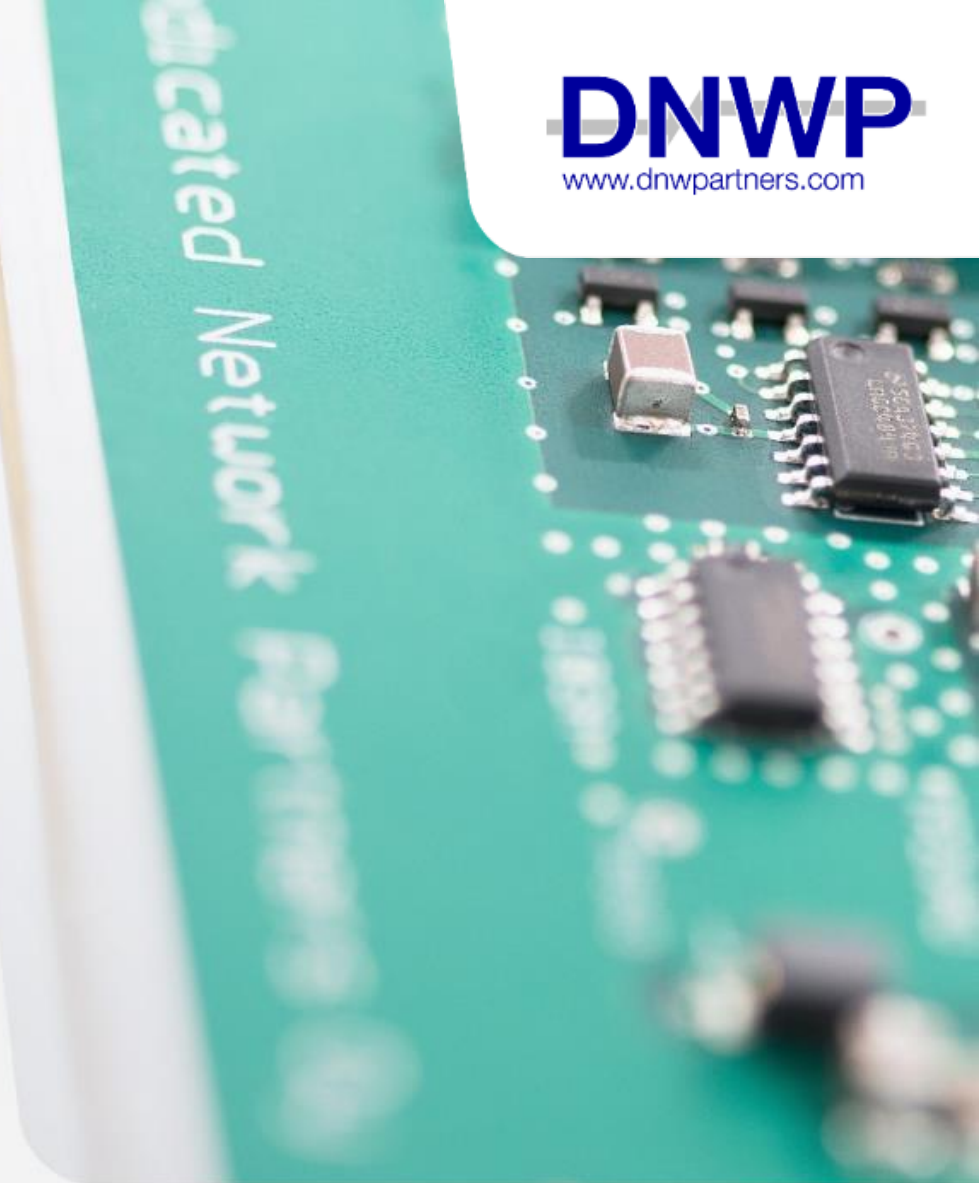

Core
10-400G

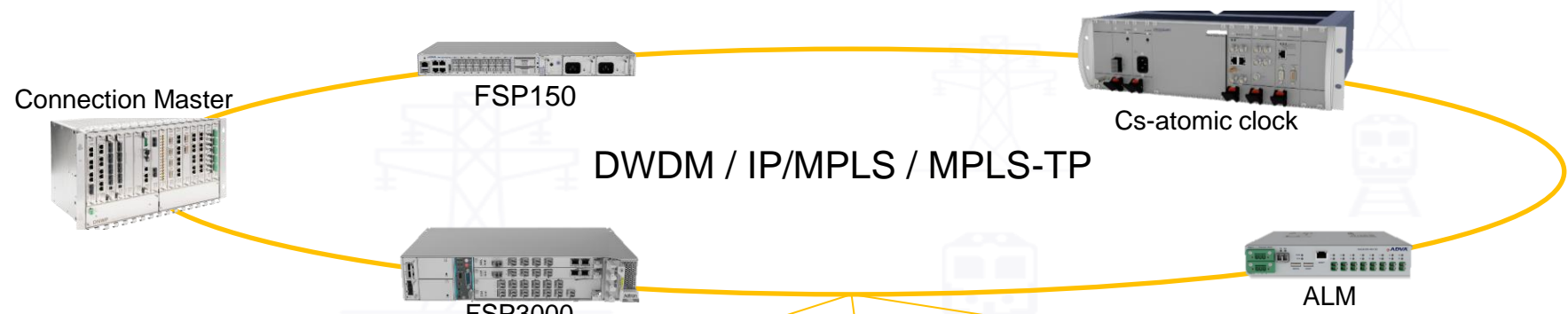

Access
64k-10G

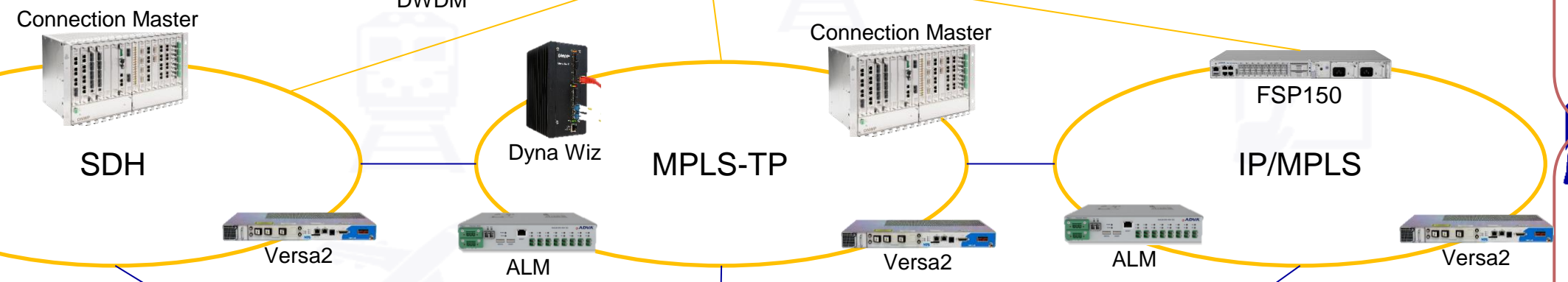

Station

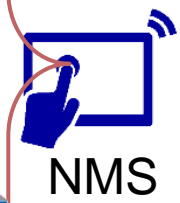
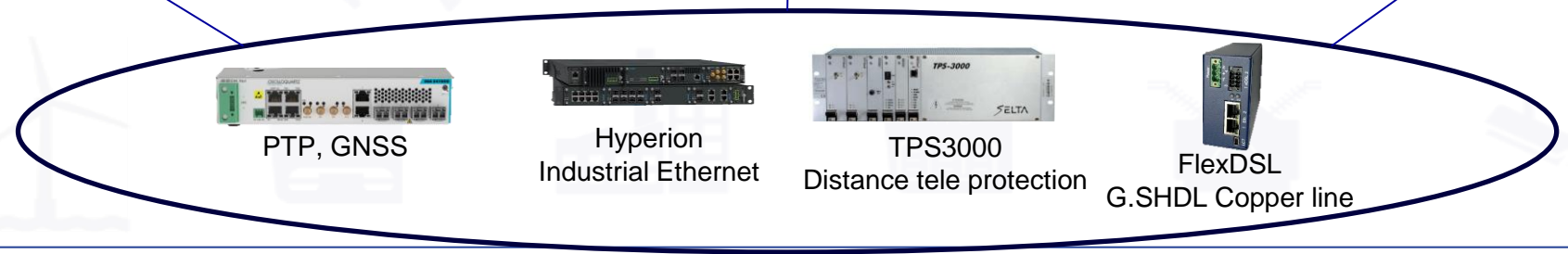

Connection Master SDH / MPLS-TP hybrid

- Connection Master provides TDM and packet based multiservice access, aggregation and transport layer optimized for utility and private networks
 - Hybrid solution: simultaneous delivery of TDM & packet-based services over networks
 - SDH Trunk interfaces: STM-1/4/16
 - MPLS-TP: 1GE/2,5GE/10GE
 - High availability
 - Optimized for strictly time critical, low latency applications
 - Migration from TDM towards to the Packet
 - A wide range of interfaces and cross-connection options
 - Compatibility towards Dynanet & FMX2

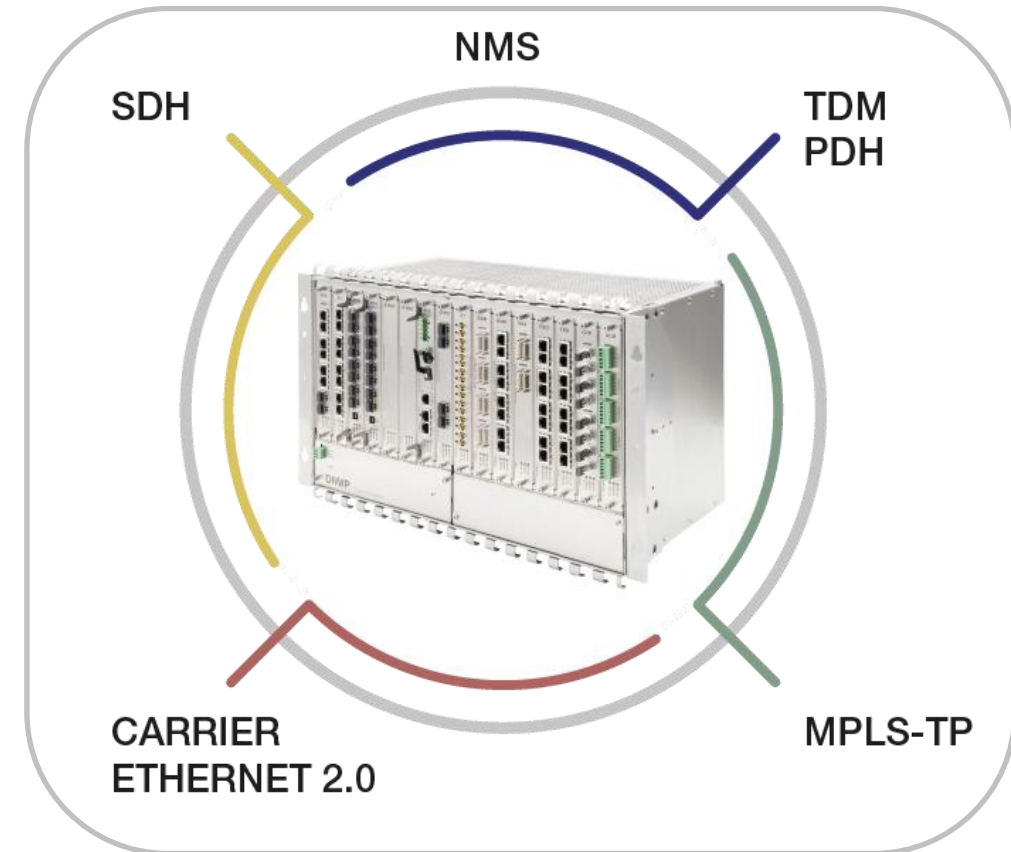

- Compact MPLS-TP switch
- DC powered, fanless, robust design
- 2x 2,5GE network interfaces
- Applications
 - Ethernet services
 - E1 transport
 - V.24 serial data
 - Teleprotection C37.94.

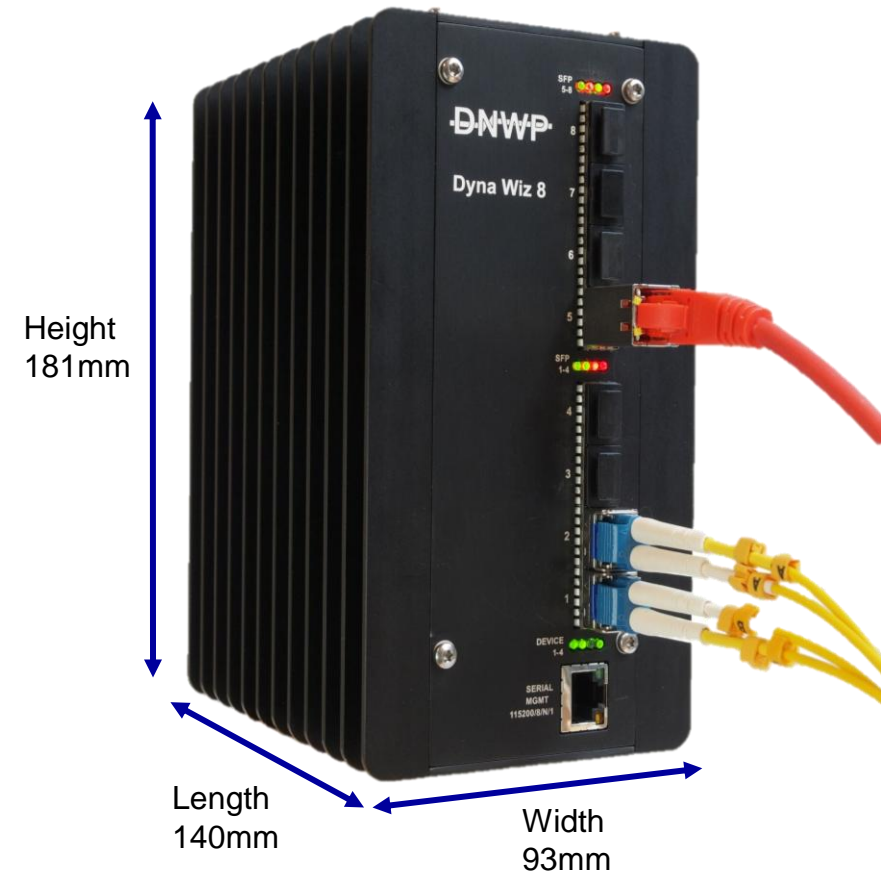

FSP150 family

- MEF CE3.0 and/or IP/MPLS
- First product with MEF 3.0-certified CE 100Gbit/s services
- Meeting the need for higher bandwidth, 1-100GE data rates
- Security hardened version for German “VS-NfD” and “EU/NATO Restricted” applications



FSP3000

- Leading DWDM platform: State-of-the-art WDM transport system, used by thousands of enterprises worldwide
- Up to 800Gbit/s line speeds
- Modular and scalable line system
- Optical encryption

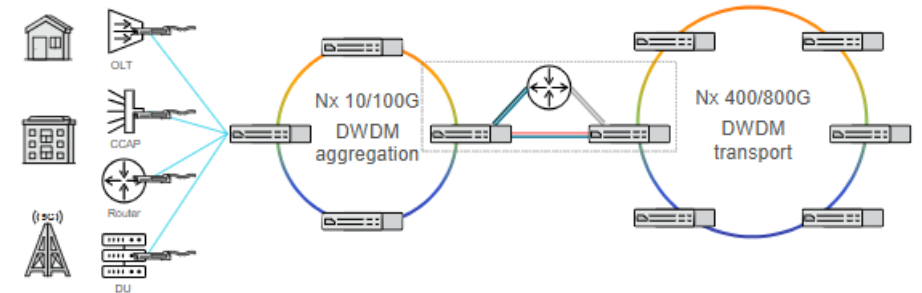

ALM

- 24/7 in service OTDR fiber monitoring system

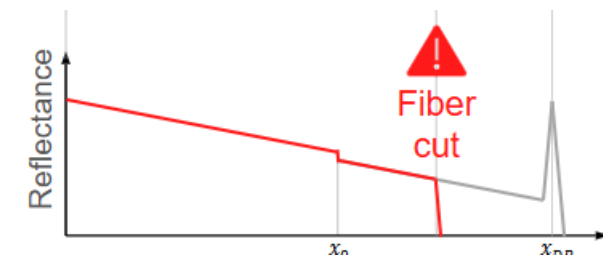

- Advanced timing & secure networking for critical defense infrastructure
- Resilient optical cesium Sync& Timing solutions: ePRTC+ and aPNT+
- OSA 5422 / OSA 3350 (GPS Clock and Optical Cesium)
- Several performance levels and form factors from Cs-atomic clocks to GNSS SFP plugs



Oscilloquartz super aPNT+™ holdover cesium clock



Hyperion



BITSTREAM

DNWP
www.dnwpartners.com

- Managed Industrial Ethernet switch up to 10GE
- Several form factors available from modular 19" rack to compact DIN rail mounted
- PTP synchronization
- MACsec - encryption and data integrity
- Lossless redundancy supporting PRP/HSR protocols
- IEC61850-3
- PoE++
- NMS integration via SNMP



MBP Versa2, optical amplifiers



- Data rates from 155 Mbps to 10 Gb/s in SDH or GbE (MPLS) protocols
- Small footprint and low power consumption
- Configurable single box solutions
- Maximum reach single box solution 69dB. With VERSA2 Raman and ROPA pumps up to 85dB
- NMS integration via SNMP



	STM-1	STM-4	STM-16	1 GbE	STM-64/10 GbE
Maximum Reach single box solution	69 dB	65 dB	59 dB	63 dB	59 dB

FlexDSL copper access



- Compact SHDSL modems for harsh environment
- SHDSL and SHDSL.bis, TC-PAM16/32. Additional TC-PAM4/8/64/128 Available
- Up to 15.2Mbps Data Transmission per single copper pair
- DSL channel bonding for 2 copper pairs in order to achieve speeds to 30.4Mbps
- Ethernet, E1 and serial data over copper pair
- Voice over IP gateway
- NMS integration via SNMP



TPS3000



- Analog and digital teleprotection equipment
- Management of contact commands and commands according to IEC 61850 protocol
- Different digital / analog line interfaces
- GOOSE messages
- NMS integration via SNMP

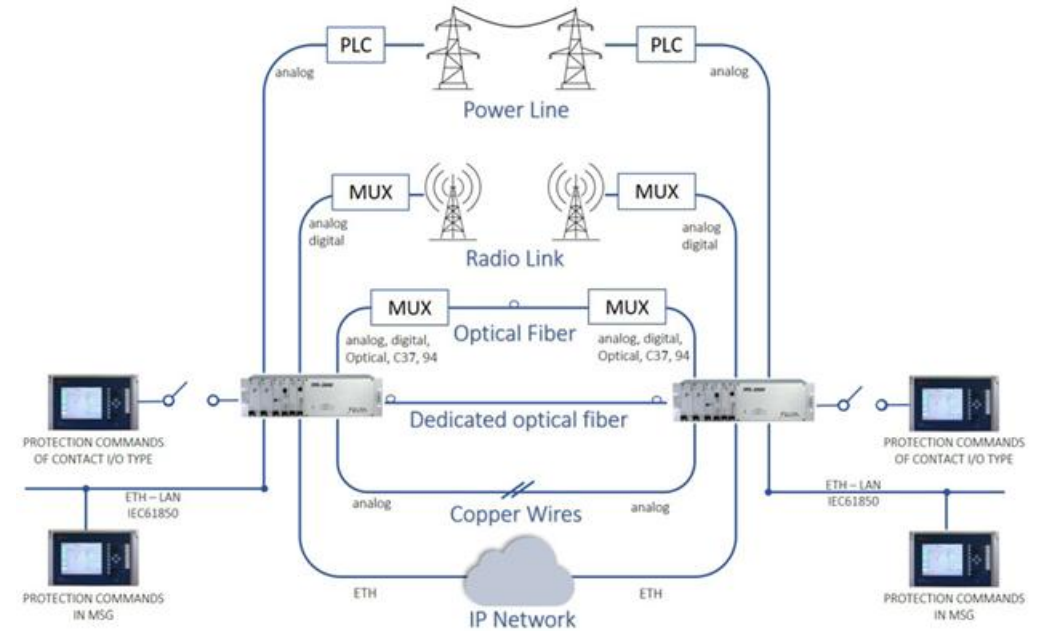

Manage any SNMP devices

- Total Network Visibility with customized dash boards and real time performance
- Detailed Network Inventory with real look device views
- Advanced Fault Management and Correlation
- Complete Network Visualization
- Advanced Network Configuration with End-to-End (E2E) provisioning.
- Device Integrator for your own device integrations

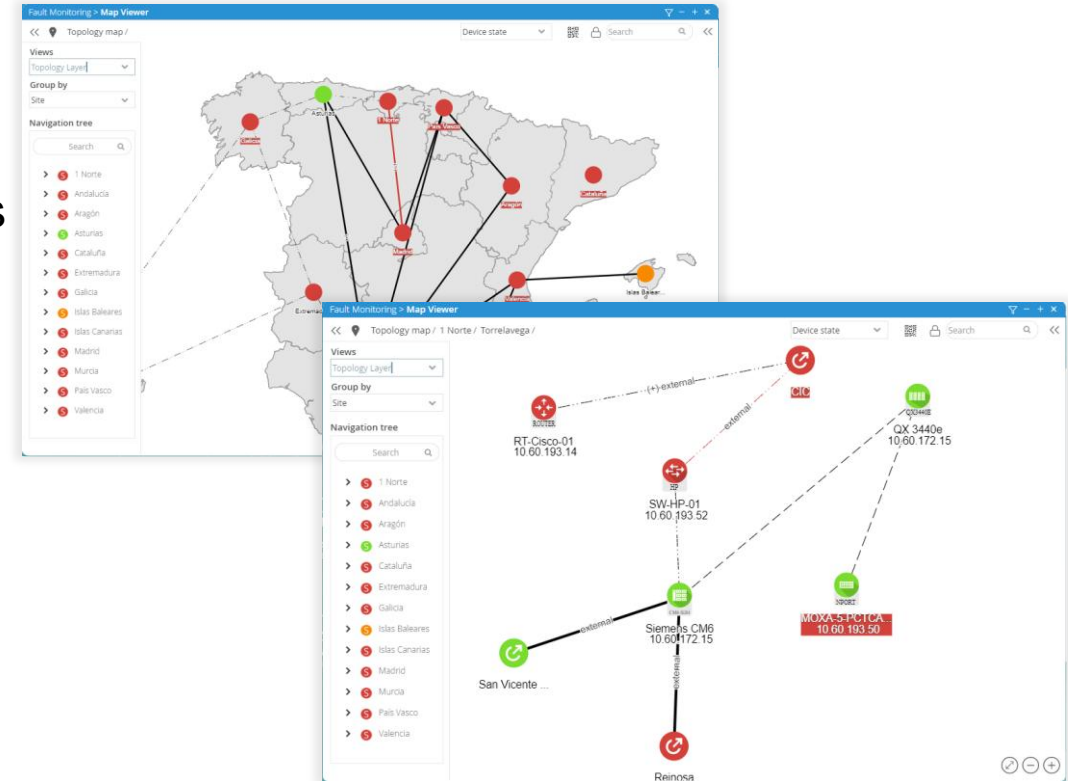

NetHero - Telenium

Manage any SNMP devices

- Fault Management – Detect network failures and navigate through the affected equipment.
- Configuration Management – Manage network elements from multiple locations and load configurations
- Accounting Management – Generate reports that reflect the information you need to know
- Performance Monitoring – Observe and analyze what level your network is performing
- Security Controls – Protect your network.

